

# Briton

## 1130 Series

Door controls



Fire Rated: Tested on fire door assemblies in accordance with Australian Standards, refer fire door manufacturer for specific approval details

The Briton 1130 Series is a non-handed, slimline closer designed to be used on commercial interior/exterior wooden and metal doors e.g. storeroom, office and toilet doors.

The 1130 is an adjustable 1-6 strength closer to suit a range of door sizes.

Door closing is hydraulically controlled, with adjustable back check and regulators to give the desired closing speed. The 1130 has a precision rack and pinion mechanism, and is easily mounted to the surface of door or the top jamb.

Hold open and track arm versions also available.

### Features

- Universal, fully reversible, non-handed door closer
- Closer body constructed from pressure die cast aluminium with steel rack and pinion
- Tested to 500,000 cycles
- Fully adjustable 1-6 strength regular arm, 1-4 strength track arm
- Factory set to strength 3
- Standard closer offers 3 installation options
  - Regular (pull side)
  - Top jamb (push side)
  - Parallel arm (push side)
- Independent adjustment valves for controlling backcheck, closing and latching speeds
- The 10 year warranty provides specifiers and users with assured quality and performance

# Specification guide

Series	Function	Finish
Briton 1130 regular closer..... BNT-1130B	Regular closer.....REG	Sprayed silver.....SE
Briton 1130 track arm closer..... BNT-1130B-T	Hold open closer.....HO	

- Series  
Select the desired series e.g. Briton 1130 regular closer ..... BNT-N1130B
- Function  
Select the desired function e.g. Hold open closer ..... BNT-N1130B-HO
- Finish  
Select the desired finish e.g. Sprayed silver ..... BNT-N1130B-HO-SE

## Track closer

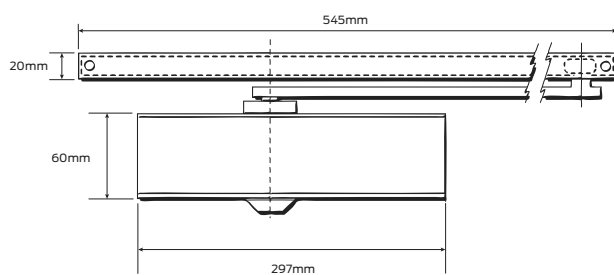

## Specifications

<b>Door type</b>	Timber or metal
<b>Door size</b>	See chart on next page
<b>Applications</b>	Regular - pull side mount Parallel arm - push side mount Top jamb - push side mount
<b>Adjustment controls</b>	Closing speed Latching speed Backcheck
<b>Strength</b>	Regular - 1-6 adjustable Track arm - 1-4 adjustable
<b>Options</b>	Hold open arm Adaptor plate Parallel arm drop plate
<b>Finish</b>	Sprayed silver
<b>Warranty</b>	10 year mechanical

## Regular closer

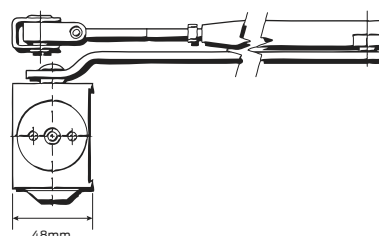
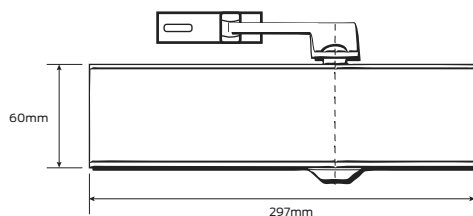

## Selection chart

Strength 2-6 adjustable	Maximum door leaf width	Door weight
Regular	850mm - 1400mm	40-120kg
Top jamb	850mm - 1400mm	40-120kg
Parallel arm	850mm - 1400mm	40-120kg
Track arm (strength 2-4 adjustable)	850mm - 1100mm	40-80kg

## Regulating controls

The Briton 1130 has independent regulators to control:

<b>Closing speed</b>	Adjustment to increase or decrease the speed at which the door closes. This allows the appropriate momentum to close the door in a safe and secure manner. Closing speed adjustment operates from the maximum opening to 15°
<b>Latching speed</b>	The latching speed allows the door to close quietly and firmly. It can be adjusted to increase or decrease the speed at which the door finally closes. This assists the final stage of the closing cycle to help overcome stubborn latch bolts or air pressure conditions. Alternatively the latching speed can be decreased to cushion the door into the frame. The latching speed adjustment operates from 15° to closing. A further option to increase the latching power is to reverse the arm bracket shoe
<b>Backcheck</b>	Adjustable hydraulic backcheck provides a cushioning effect to prevent damage to the closer, door and frame when the door is forcibly thrown open. The backcheck adjustment allows the level of resistance in the latter stage of opening to be set at the level required. Backcheck is effective from 75°. Backcheck is a requirement for all fire rated closers

## Functions

<b>Regular</b>	For applications where the door must fully close after each opening
<b>Hold open</b>	Suitable for doors where the door may need to be left in a hold open position. The hold open function can be set to hold open at a single point. Hold open closers can not be used on fire doors

# Regular closer mounting details

## Regular

Closer is fixed to the pull (hinge) side of door

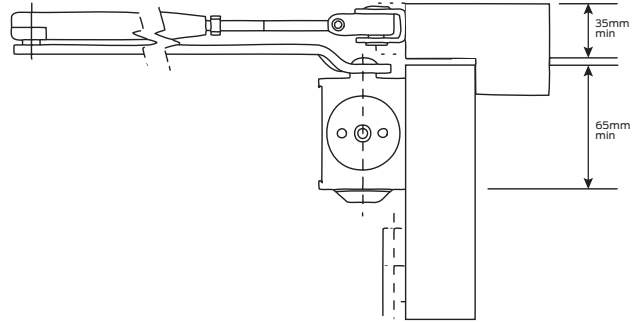

## Top jamb

Closer is fixed to top jamb on push (opposite to hinge) side of door

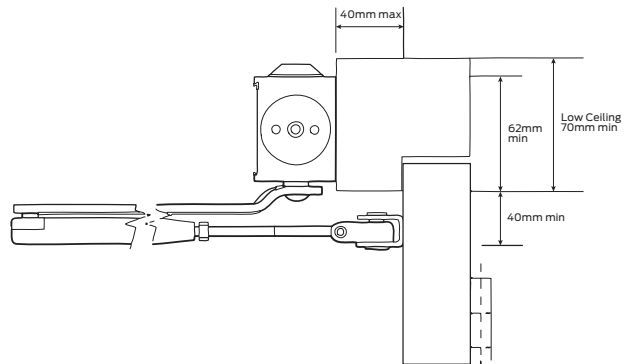

## Parallel arm

Closer is fixed to the push (opposite to hinge) side of the door

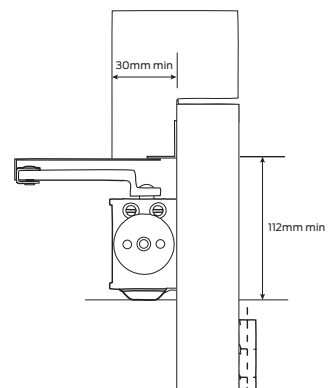

## Track closer mounting details

### Pull side

Closer is fixed to the pull (hinge) side of door

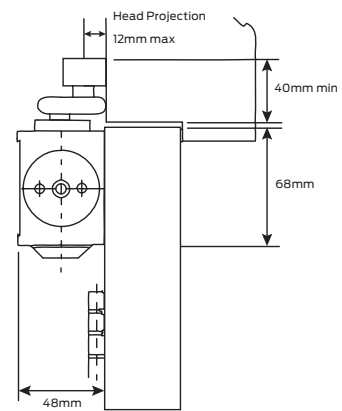

### Top jamb

Closer is fixed to the top jamb on the pull (hinge) side of door

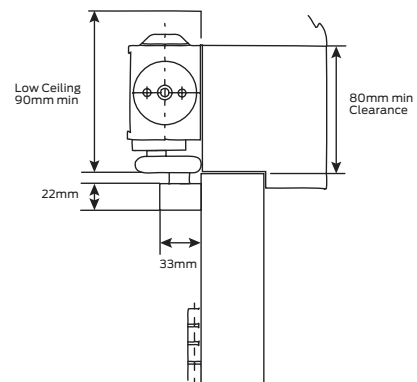

## Briton 1130 Series accessories

### Hold open arm 1130-HO

Allows door to be held open at desired position. Strength of hold open is adjustable

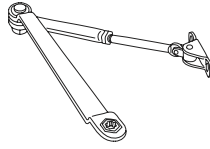

### Square metal cover

**Finishes:** Satin stainless steel, polished stainless steel

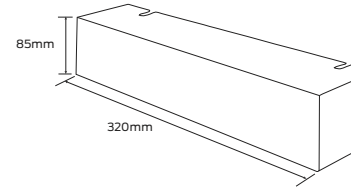

### Track arm 1130-T

The track arm is able to be mounted in pull side and top jamb configurations

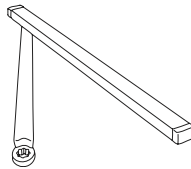

### Parallel arm drop plate 1130-PADP

To be used where the top rail is insufficient to mount a closer in parallel arm configuration

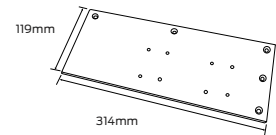

### Parallel arm bracket 1130-PA

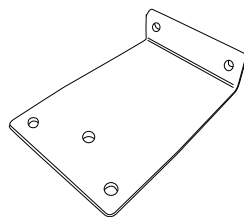
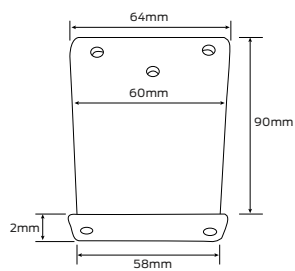

### Adapter plate pull side 1130-AP

To be used where either the top rail or head frame is insufficient to mount closers in regular or top jamb configurations

